

ISTRUZIONI DI MONTAGGIO

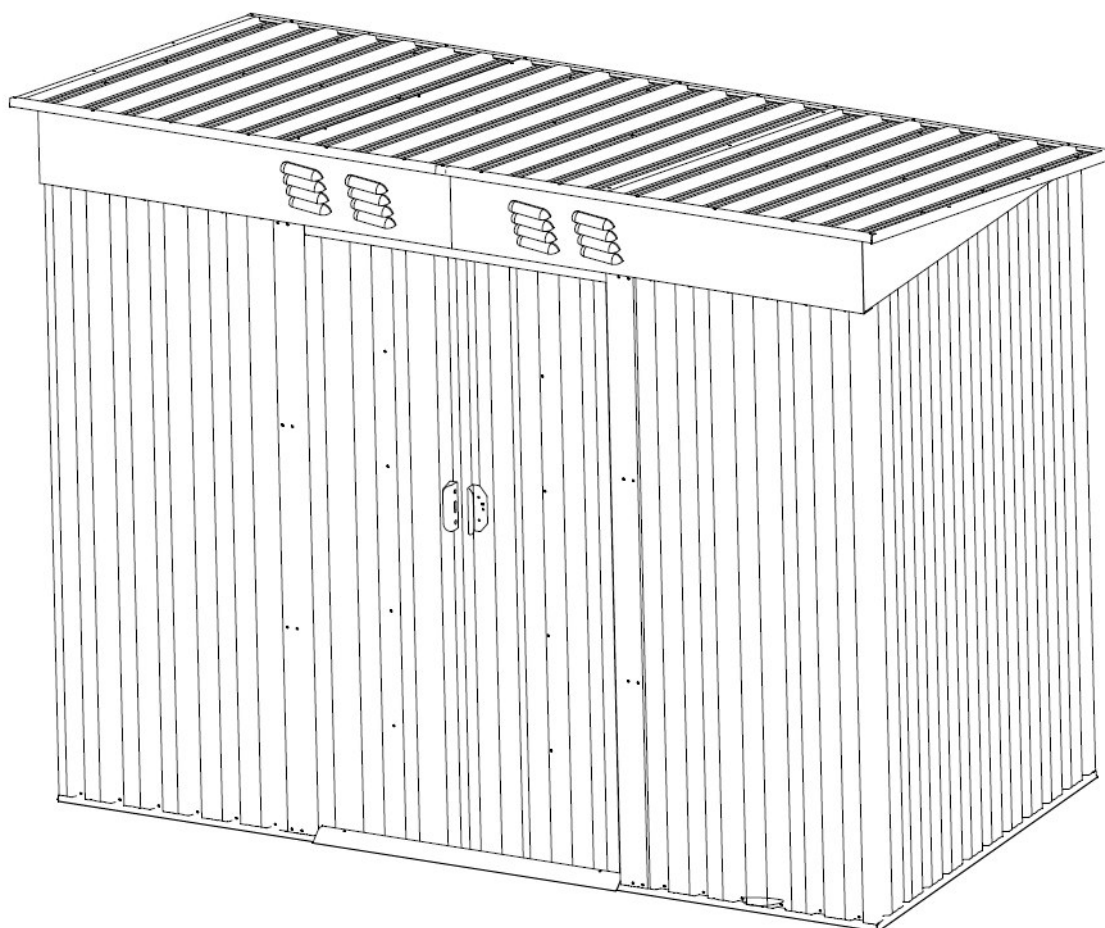

ART. C1351002 CASETTA MEDIUM STORE

STRUTTURA IN LAMIERA PREVERNICIATA
PARETI RINFORZATE
PORTE SCORREVOLI
COLORE VERDE
MADE IN CHINA

E' un prodotto selezionato e distribuito da:
BIACCHI GIANFRANCO srl – Via Luigi Einaudi n° 1 – 26041 Casalbellotto - CR - Tel. 0375/59345 – Fax. 0375/59765
www.biacchi.com

OPERAZIONI PRELIMINARI:

INFORMATEVI SULLE NORMATIVE IN MERITO AL REGOLAMENTO EDILIZIO LOCALE.

NON MONTARE LA CASSETTA IN GIORNATE DI PIOGGIA O VENTO.

PRESTARE ATTENZIONE AL TERRENO, SCEGLIERE UNA ZONA PIANEGGIANTE, NON DEVE ESSERE BAGNATO.

USARE SEMPRE I GUANTI DA LAVORO PER MONTARE LA CASSETTA.

ALCUNI COMPONENTI IN LAMIERA POSSONO AVERE IL BORDO TAGLIENTE, USARE CAUTELA.

PER IL MONTAGGIO DELLA CASSETTA SONO NECESSARIE DUE PERSONE.

ISTRUZIONI DI MONTAGGIO:

QUESTO MANUALE FORNISCE TUTTE LE ISTRUZIONI E LE INFORMAZIONI NECESSARIE PER COSTRUIRE AL MEGLIO LA SUA CASSETTA. LEGGETELE ATTENTAMENTE PRIMA DI INIZIARE IL MONTAGGIO E SEGUITELE DI PASSO IN PASSO IN MODO DA OTTENERE UN RISULTATO OTTIMALE.

LISTA MATERIALE:

CONTROLLATE DI AVERE A DISPOSIZIONE TUTTO IL MATERIALE NECESSARIO PER INIZIARE IL MONTAGGIO. CONTROLLATE CHE IL MATERIALE CHE VI VIENE FORNITO CORRISPONDA A QUELLO DESCRITTO SULLA LISTA DEGLI ARTICOLI IN DOTAZIONE. PRENDETE CONFIDENZA CON GLI ARTICOLI IN MODO DA FACILITARVI L'USO .

CURA E MANTENIMENTO:

PER MANTENERLA INALTERATA NEL TEMPO, LAVATELA PERIODICAMENTE.

RITOCCHATE IMMEDIATAMENTE EVENTUALI GRAFFI.

MANTENERE IL TETTO LIBERO DA NEVE O FOGLIE .

CHIUDETE SEMPRE LA PORTA IN MODO DA EVITARE DANNI CAUSATI DAL VENTO.

MANTENETE SEMPRE LA GUIDA DELLA PORTA LIBERA DA DETRITI IN MODO DA EVITARE DIFFICOLTA' NELLO SCORRIMENTO DELLA STESSA.

LUBRIFICATE ANNUALMENTE LA PORTA IN MODO DA EVITARE DANNI.

















AVVITARE A FONDO I DADI, VITI E BULLONI SOLO A MONTAGGIO COMPLETATO.

















CONTROLLATE REGOLARMENTE CHE NON VADANO PERSI DADI, VITI E BULLONI E REINTEGRATELI NEL CASO VENGANO PERSI.



UNA BUONA VENTILAZIONE, PUO' RIDURRE LA FORMAZIONE DI CONDENSA.

NON METTETE ALL'INTERNO DELLA CASSETTA COMBUSTIBILI O SOSTANZE CORROSIVE.

LISTA MATERIALE

PART	NO.	Qty.
	1	1
	2	1
	3L	1
	3R	1
	4L	1
	4R	1
	5	1
	6	1
	7	1
	8	1
	9	1
	10L	1
	10R	1
	11	1
	12L	1
	12R	1
	15	2

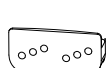
PART	NO.	Qty.
	17	4
	20	4
	21L	1
	21R	1
	25L	1
	25R	1
	27	2
	B1	4
	P1	4
	P2	4
	P3	2
	P4	2
	P5	2
	P6	2
	P7	1
	D1	1

PART	NO.	Qty.
	D2	1
	G2	4
	GB	2
	GC	4
	GD	4
	GF	2
	F1	180
	F2	50
	F3	8

PUNTO 1

Assemblate i profili a pavimento (1, 4L, 4R, 2, 3L, 3R) con viti (F1).

Fate in modo che i profili formino tra loro un angolo di 90°.

Ponete il profilo di scorrimento della porta (5) sulla parte superiore del profilo (3L, 3R).
Fissatelo con le viti (F1).

Attenzione ai bordi taglienti

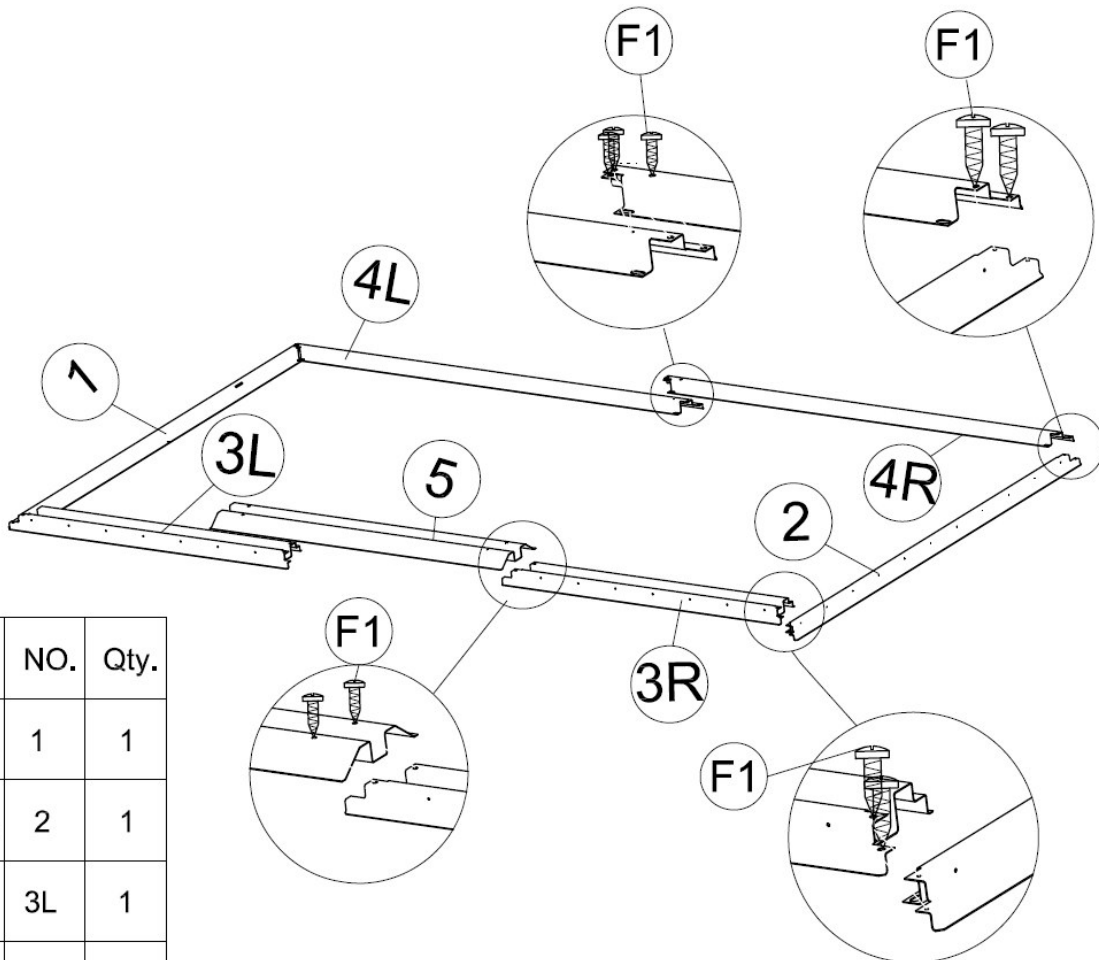



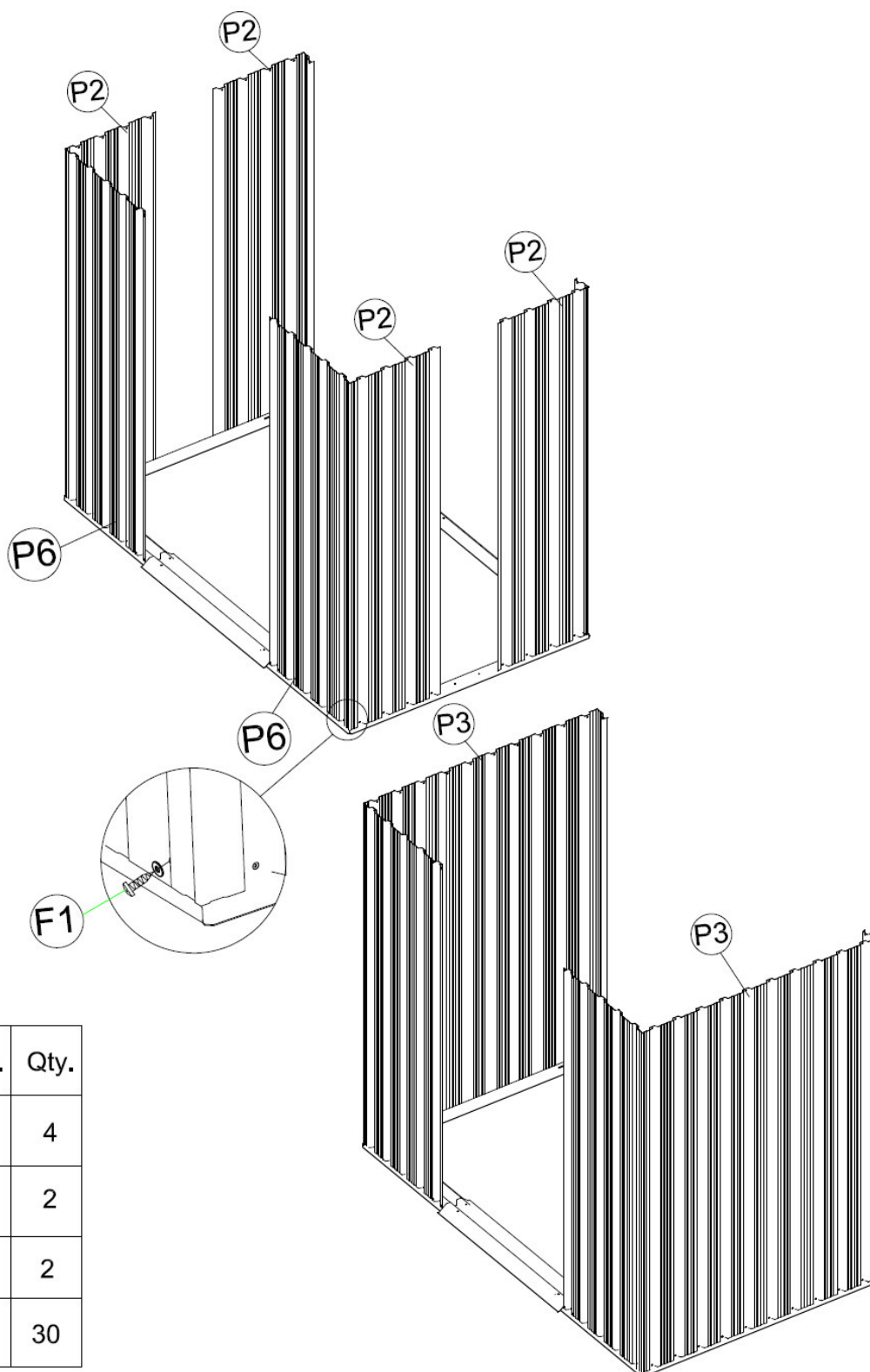

PART	NO.	Qty.
	1	1
	2	1
	3L	1
	3R	1
	4L	1
	4R	1
	5	1
	F1	16

PUNTO 2

Posizionate le pareti (P2, P3, P6) sui profili a pavimento (1, 3L, 3R, 2).
Allineate le pareti laterali ai fori dei profili a pavimento.
Fissatele con le viti (F1) dall'esterno.



PART	NO.	Qty.
	P2	4
	P3	2
	P6	2
	F1	30

PUNTO 3

Inserite i due fermi (G2) nei canali di scorrimento (7, 8).

Montate il profilo della porta (6) tra le due pareti frontali (P6).





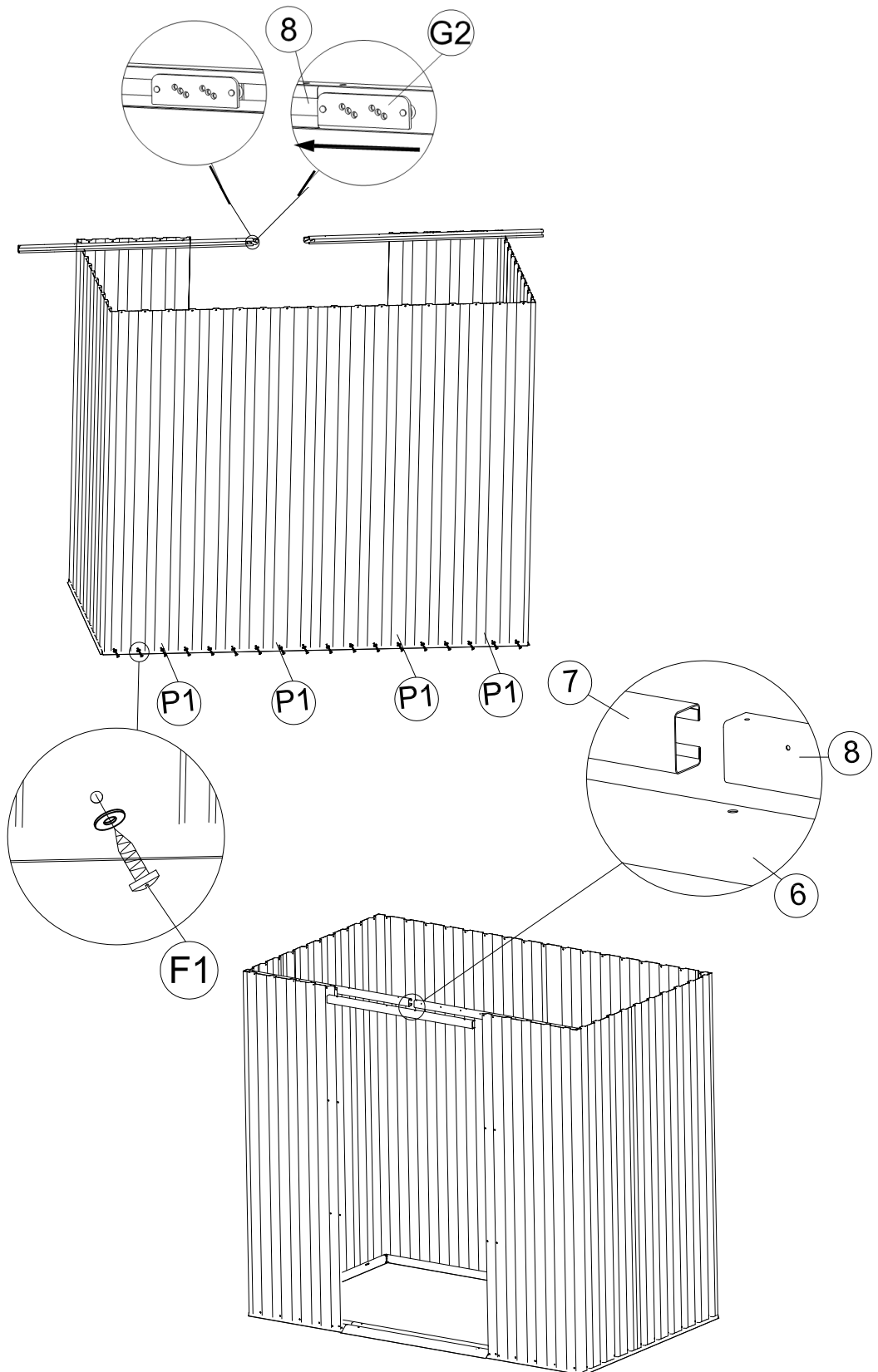

Posizionate i canali di scorrimento (7, 8) nella parte superiore delle due pareti frontali dall'interno.

Posizionate le pareti (P1) sui profili del pavimento (4L, 4R).

Allineate le pareti posteriori (P1) ai fori dei profili del pavimento.

Fissatele con viti e rondelle (F1).

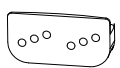



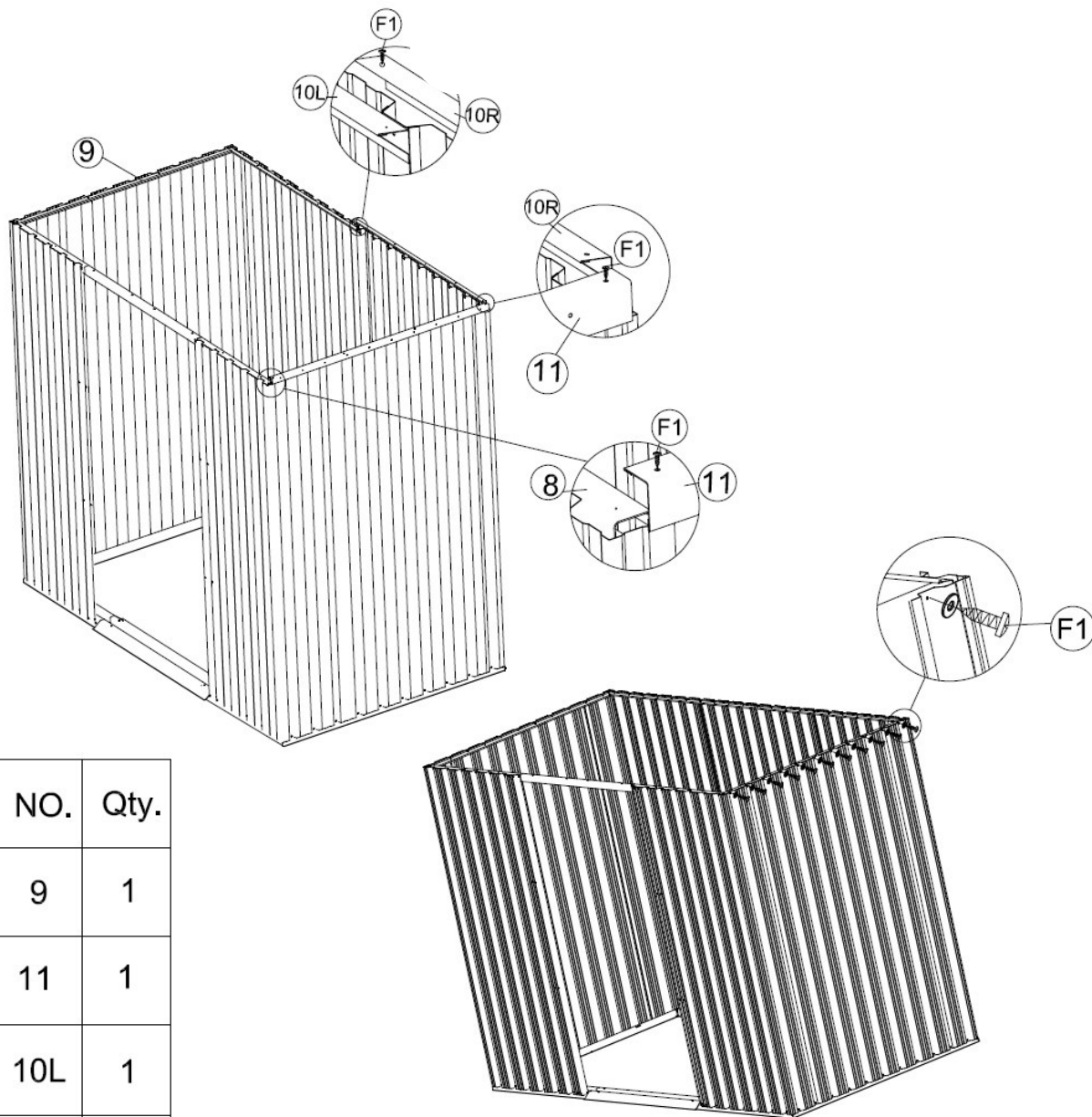

PART	NO.	Qty.
	6	1
	7	1
	8	1
	P1	4
	G2	4
	F1	28

PUNTO 4

Posizionate i profili di testa angolari (9, 10L, 10R) nella parte superiore delle pareti. Allineate i fori con le pareti (P1, P2, P3) e fissateli con le viti (F1).





PART	NO.	Qty.
	9	1
	11	1
	10L	1
	10R	1
	F1	39

PUNTO 5

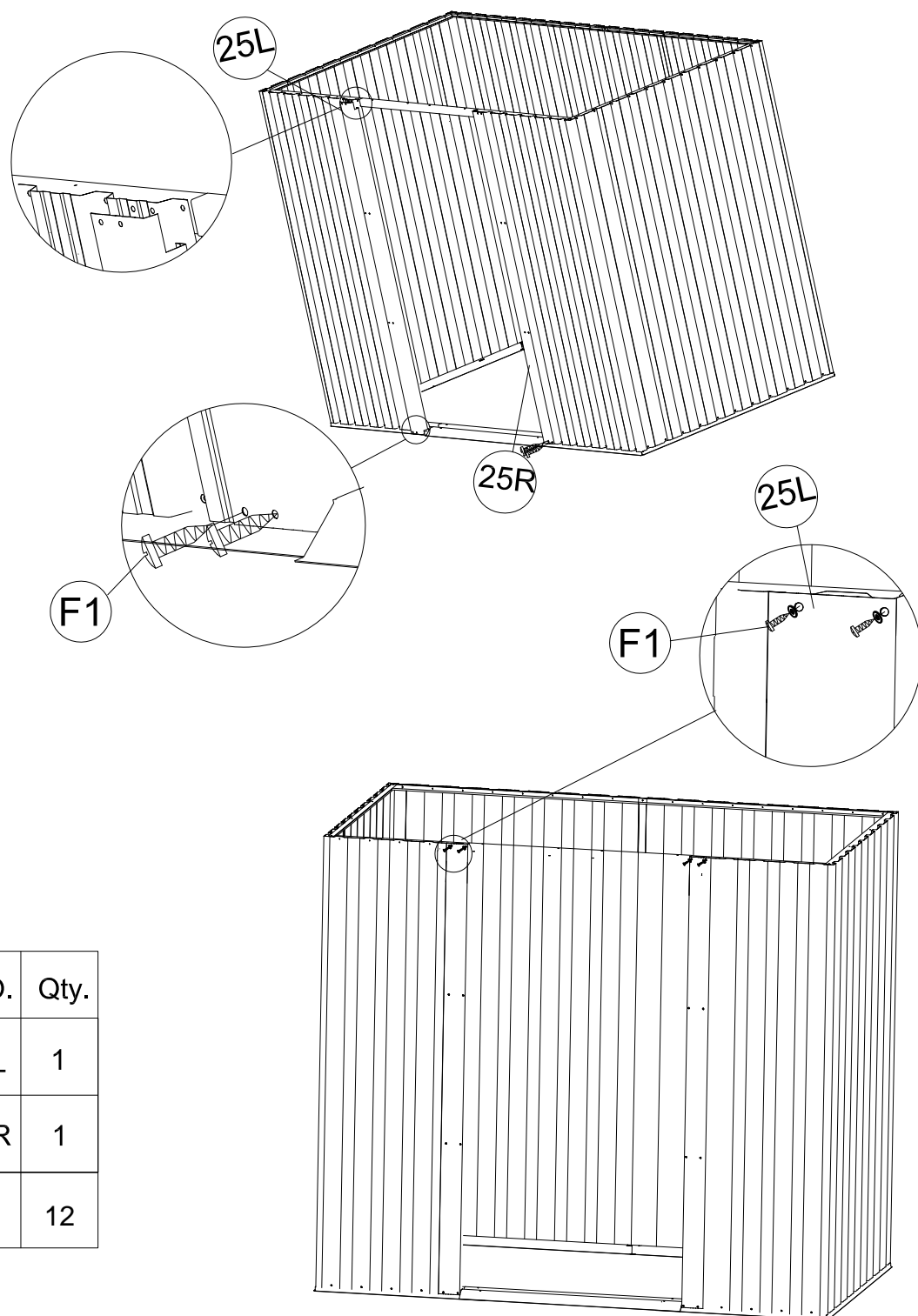
Posizionate la colonna della porta di sinistra (25L) e della porta di destra (25R) sul profilo del pavimento (3L e 3R). Inserite nella parete del pannello ed avvitata con (F1).



PART	NO.	Qty.
	25L	1
	25R	1
	F1	12

PUNTO 6

Posizionate i timpani (12R, 21R) sulla sommità del canale di scorrimento (6) e profilo di testa laterale (9). Allineate i fori e avvitateli dall'interno (F1). Ripetete la stessa cosa per i timpani (12L, 21L). Successivamente unite i timpani con le staffe (B1) con le relative viti e dadi (F2).

Inserite le due grate di areazione (GF).

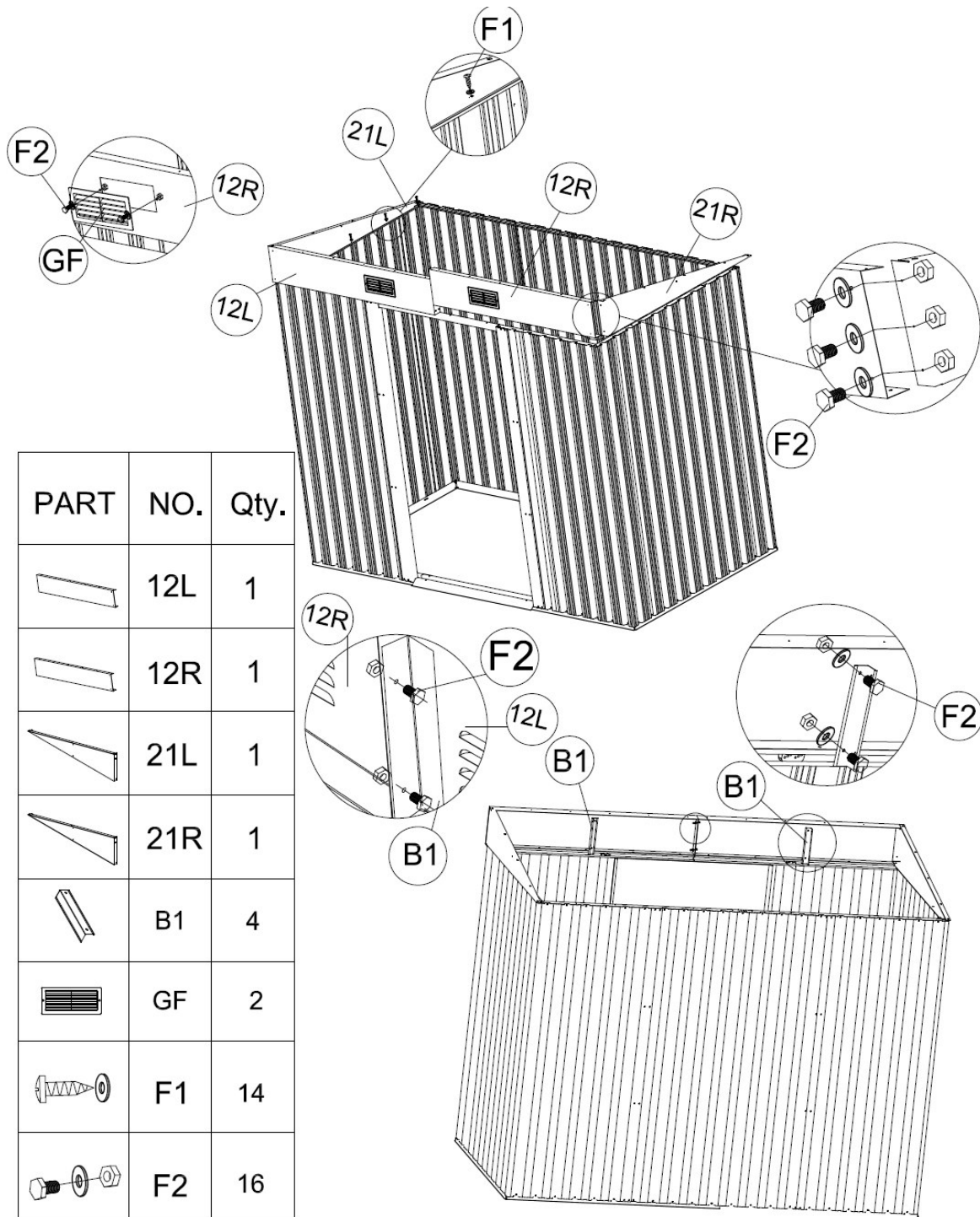

PUNTO 7



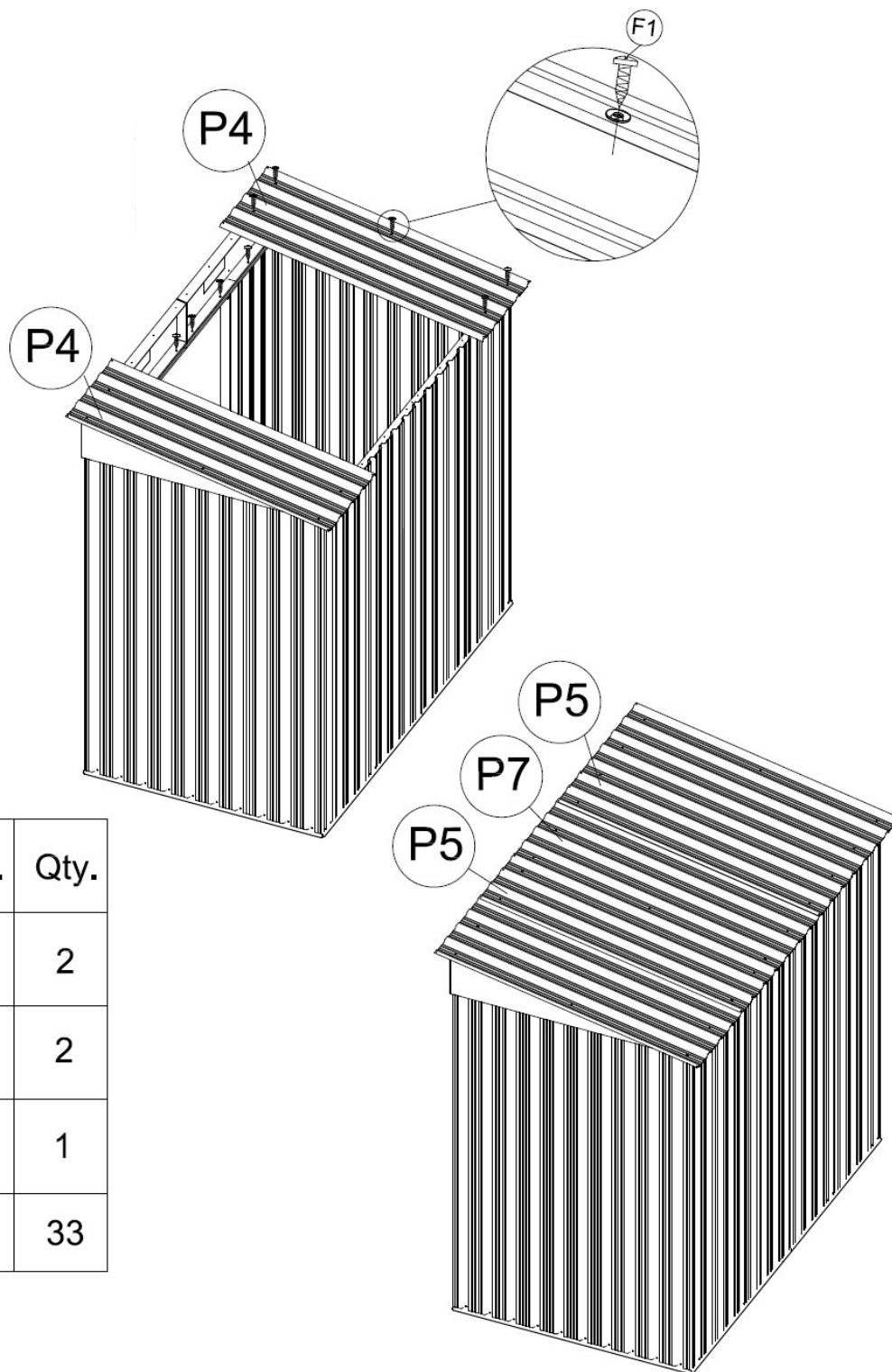

Posizionate i pannelli di copertura (P4, P5, P7) sui supporti del tetto.
Allineate i fori e avvitateli con viti e rondelle (F1).

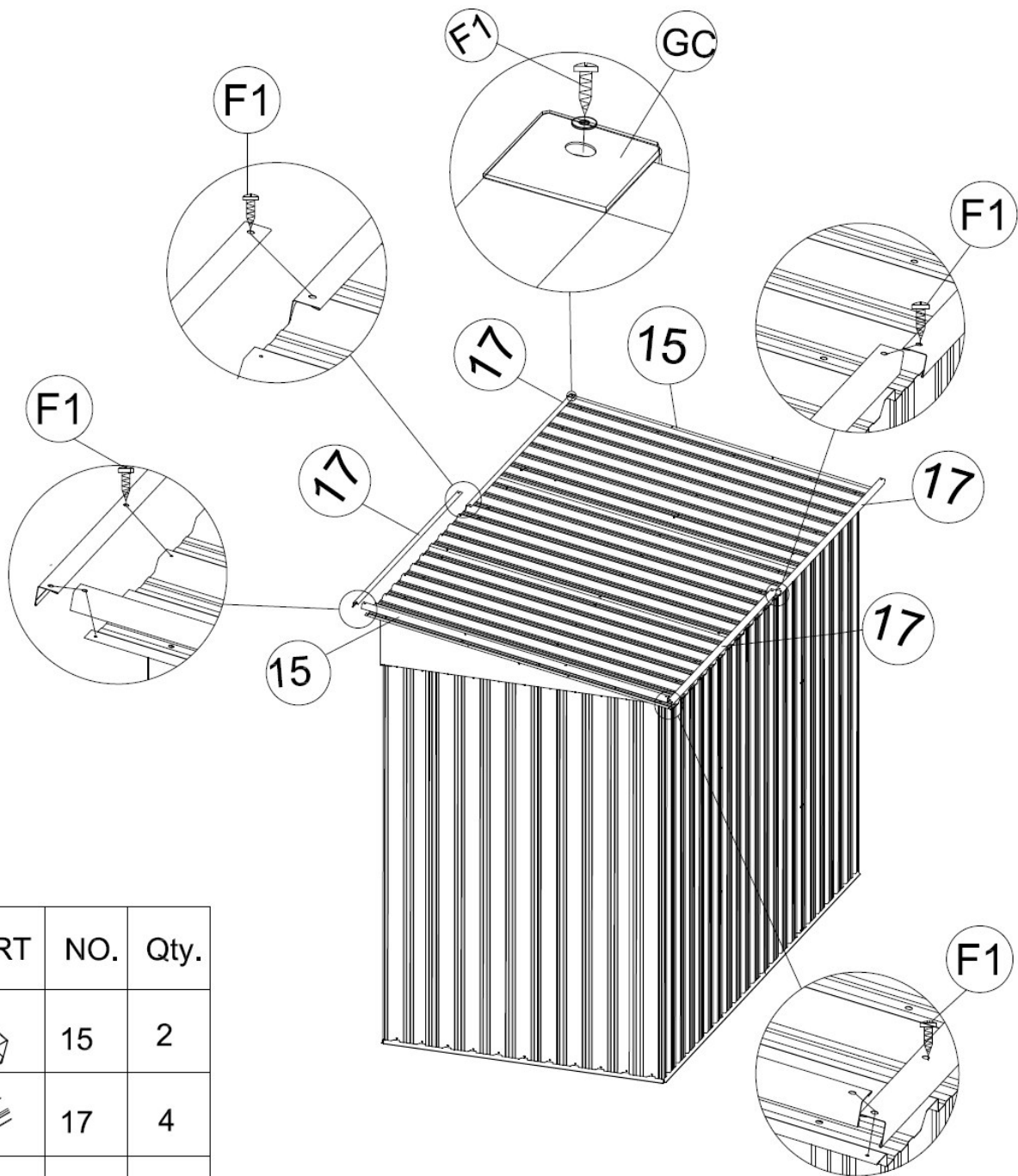

PUNTO 8

Avvitare i profili laterali esterni (15, 17) al tetto con viti e rondelle (F1).
Successivamente posizionate i quattro angolari (GC) ai profili laterali esterni ed avvitateli con viti e rondelle (F1).



PART	NO.	Qty.
	15	2
	17	4
	GC	4
	F1	6

PUNTO 9

Avvitare i profili di testa (20) ai pannelli della porta (D1, D2), in seguito fissarli con la barra di supporto (27). Poi assemblate ai profili inferiori (20) i fermi (GD), fissateli con viti, rondelle e dadi (F2).

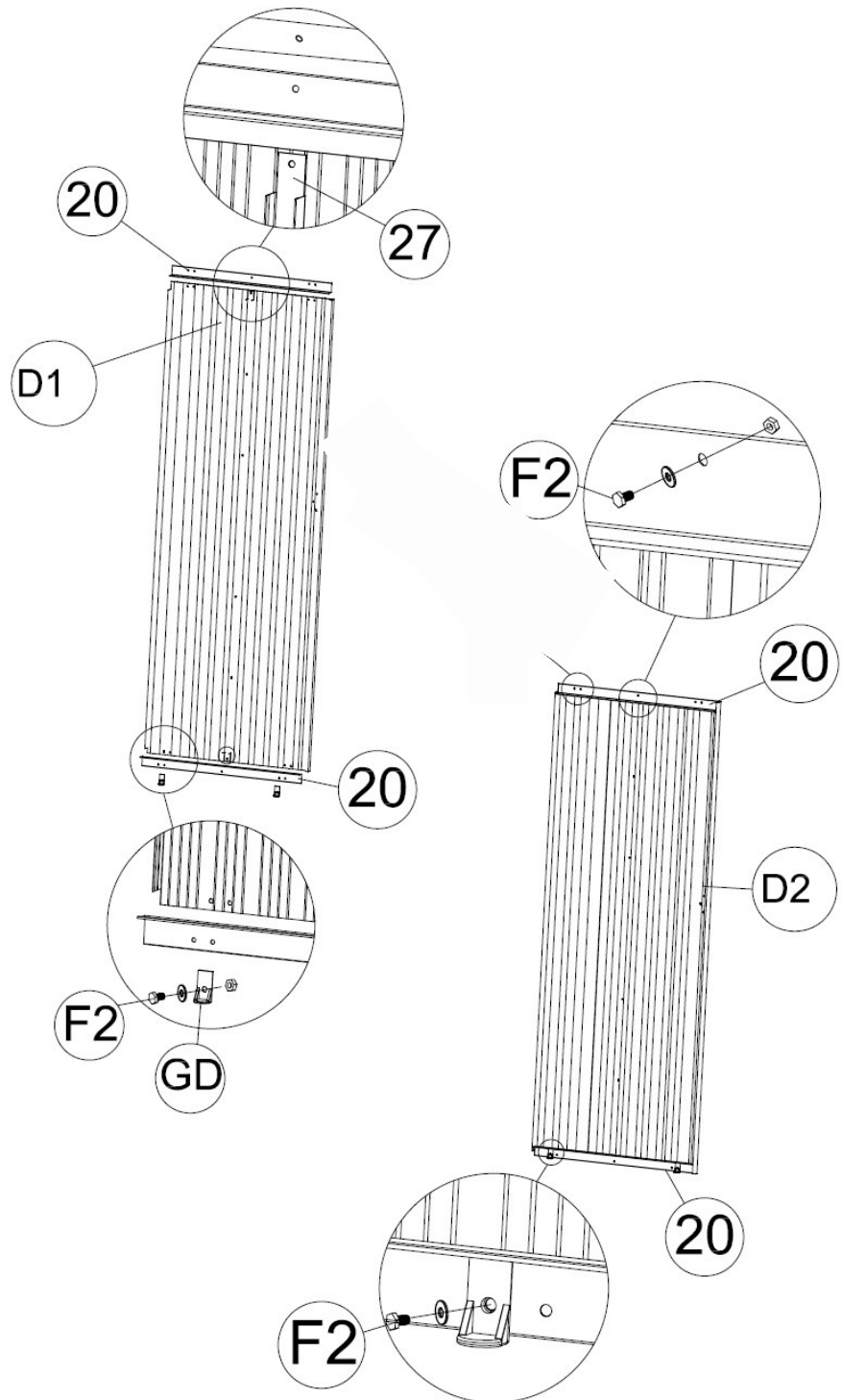

PART	NO.	Qty.
	27	2
	20	4
	D1	1
	D2	1
	GD	4
	F2	16

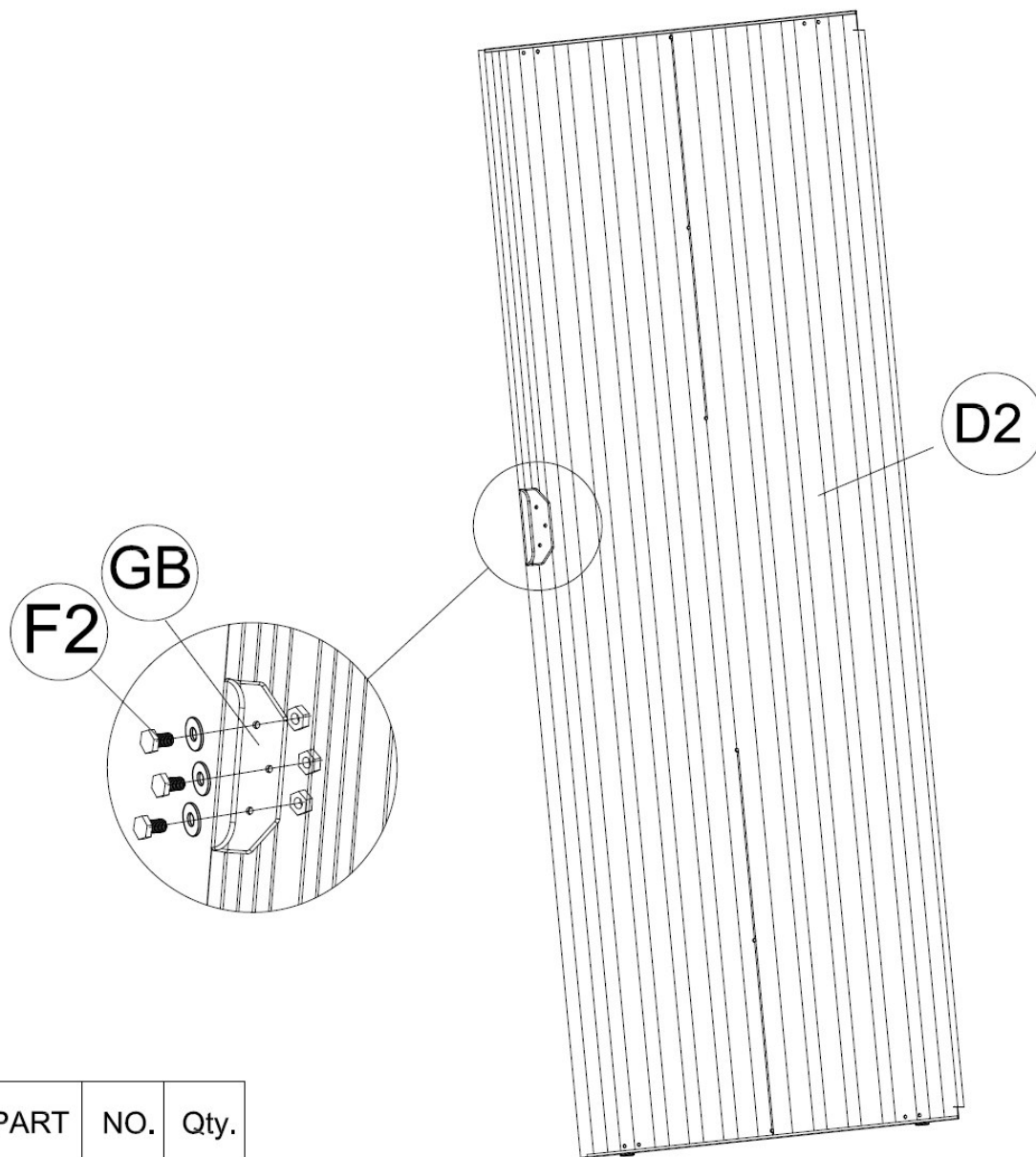

PUNTO 10

Fissate le due maniglie (GB) ai pannelli della porta (D2, D1) dall'interno con le viti, rondelle e dadi (F2).



PART	NO.	Qty.
	GB	2
	F2	6

PUNTO 11

Fate scorrere i pannelli della porta (D1, D2) nel profilo (3L). Accertatevi che i fermi (GD) scorrano all'interno della guida (3L). Fate in modo di allineare perfettamente le due porte. Fissate i pannelli superiori delle porte (20) ai fermi (G2) con viti e rondelle (F3).

